

Interval Constraints Overview

Jorge Cruz

DI/FCT/UNL

Oct 2016

Lecture 1: Interval Constraints Overview

Continuous Constraint Satisfaction Problems

Continuous Constraint Reasoning

Representation of Continuous Domains

Pruning and Branching

Solving Continuous CSPs

Constraint Propagation

Consistency Criteria

Practical Examples

Course Structure

Constraint Reasoning

Continuous CSP (CCSP):

Constraint Satisfaction Problem (CSP):

set of variables

set of domains

set of constraints

→ Intervals of reals
[a,b]

→ Numeric
(=, ≤, ≥)

Solution: → Many

assignment of values which satisfies all the constraints

GOAL Find Solutions;
Find an enclosure of the solution space

Constraint Reasoning

Continuous Constraint Satisfaction Problem (CCSP):

Interval Domains

Numerical Constraints

Many Solutions

$$x=1, y=1, z=1$$

...

$$x=1, y=1, z=3.25$$

...

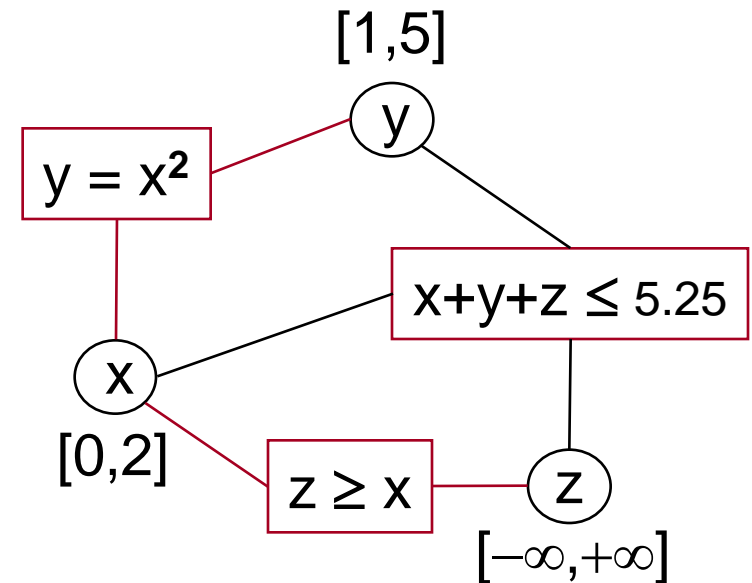

Solution:

assignment of values which satisfies all the constraints

GOAL Find solutions;
Find an enclosure of the solution space

Representation of Continuous Domains

F-interval

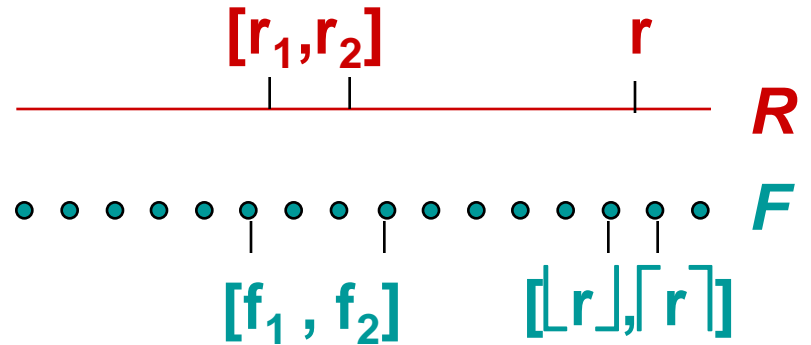

F-box

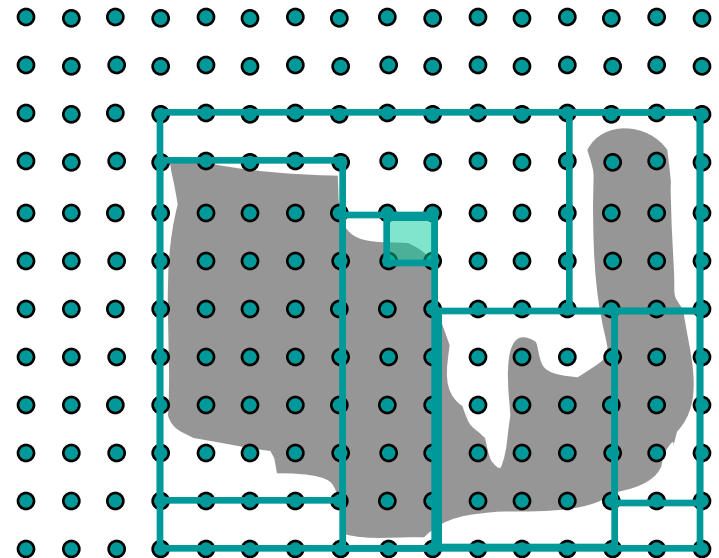

Canonical solution

Solving CCSPs:

Branch and Prune algorithms

constraint propagation

box split

Safe Narrowing Functions

Strategy for

isolate canonical solutions

provide an enclosure of the solution space

depends on a consistency requirement

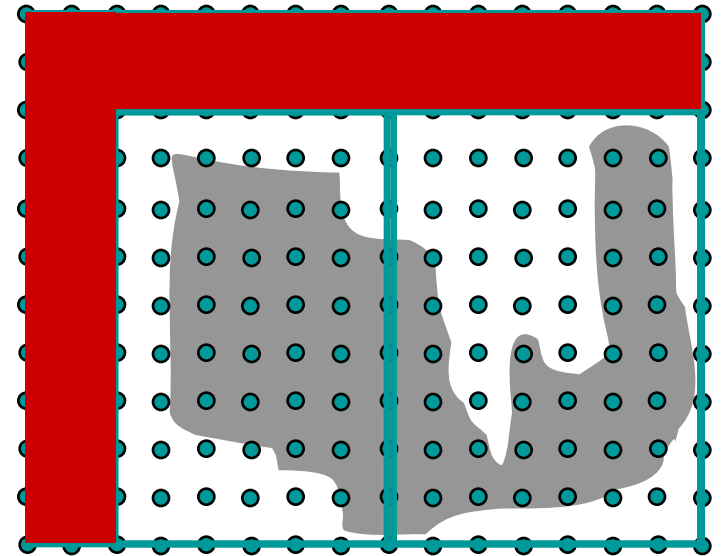

Constraint Reasoning (vs Simulation)

Represents uncertainty as intervals of possible values

Uses safe methods for narrowing the intervals accordingly to the constraints of the model

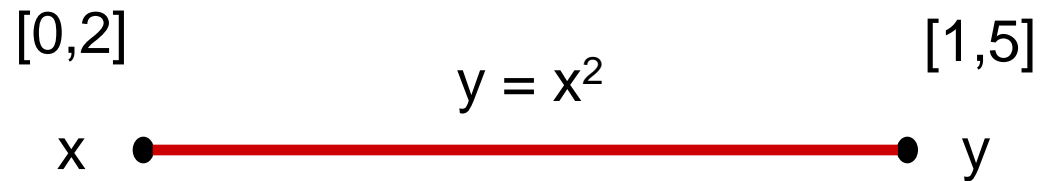

Simulation:

	0	0	no
$x \leq 1?$	1	1	
	2	4	$y \geq 4?$

Constraint Reasoning:

$[1,2]$	$[1,4]$
---------	---------

How to narrow the domains?

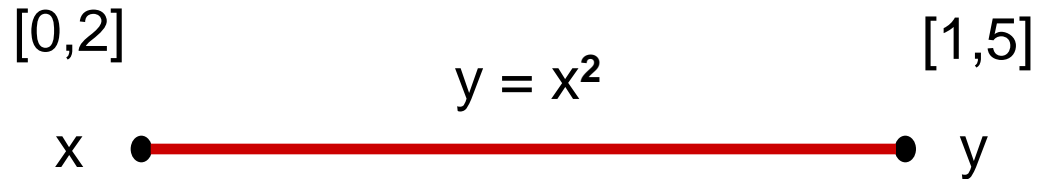

Safe methods are based on Interval Analysis techniques

$$\forall_{x \in [a,b]} x^2 \in [a,b]^2 = \begin{cases} [0, \lceil \max(a^2, b^2) \rceil] & \text{if } a \leq 0 \leq b \\ [\lfloor \min(a^2, b^2) \rfloor, \lceil \max(a^2, b^2) \rceil] & \text{otherwise} \end{cases}$$

If $x \in [0,2]$

Then $y \in [0,2]^2 = [0, \lceil \max(0^2, 2^2) \rceil] = [0,4]$

$$\therefore y \in [1,5] \wedge y \in [0,4]$$

$$\therefore y \in [1,5] \cap [0,4]$$

$$\therefore y \in [1,4]$$

How to narrow the domains?

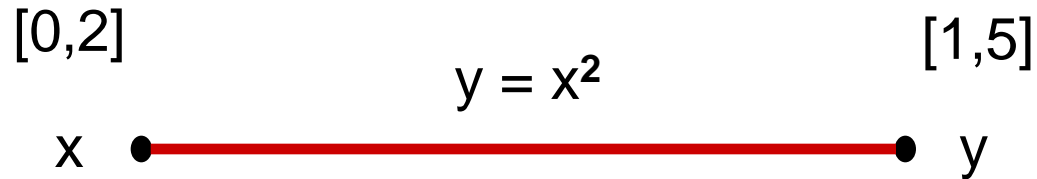

Safe methods are based on Interval Analysis techniques

$$\forall_{x \in [a,b]} x^2 \in [a,b]^2 = \begin{cases} [0, \lceil \max(a^2, b^2) \rceil] & \text{if } a \leq 0 \leq b \\ [\lfloor \min(a^2, b^2) \rfloor, \lceil \max(a^2, b^2) \rceil] & \text{otherwise} \end{cases}$$

$$\text{NF}_{y=x^2}: Y' \leftarrow Y \cap X^2$$

How to narrow the domains?

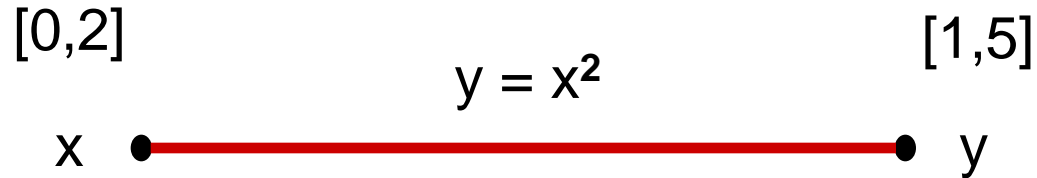

Safe methods are based on Interval Analysis techniques

$$y - x^2 = 0 \longrightarrow F(Y) = Y - [0,2]^2 \quad F'(Y) = 1$$

$$\forall_{y \in Y} \forall_{x \in [0,2]} y - x^2 = 0 \Rightarrow y \in N(Y) = c(Y) - \frac{F(c(Y))}{F'(Y)}$$

If $x \in [0,2]$ and $y \in [1,5]$

Interval Newton method

Then $y \in N([1,5]) = 3 - \frac{3 - [0,2]^2}{1} = [0,4]$

$$\therefore y \in [1,5] \cap [0,4]$$

$$\therefore y \in [1,4]$$

How to narrow the domains?

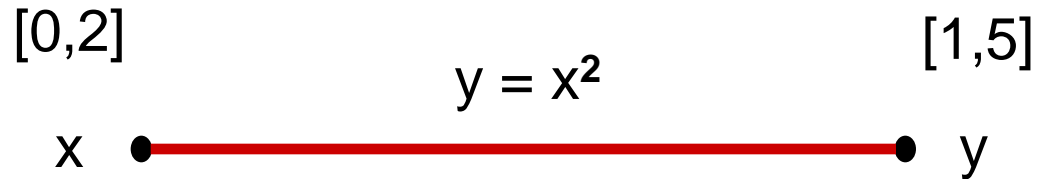

Safe methods are based on Interval Analysis techniques

$$y - x^2 = 0 \longrightarrow F(Y) = Y - [0,2]^2 \quad F'(Y) = 1$$

$$\forall_{y \in Y} \forall_{x \in [0,2]} y - x^2 = 0 \Rightarrow y \in N(Y) = c(Y) - \frac{F(c(Y))}{F'(Y)}$$

Interval Newton method

$$\text{NF}_{y=x^2}: Y' \leftarrow Y \cap \left(c(Y) - \frac{c(Y) - X^2}{1} \right)$$

How to narrow the domains?

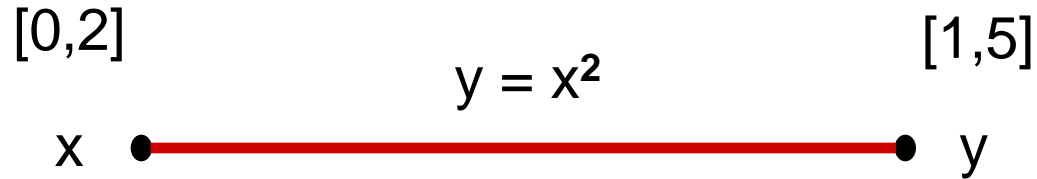

Safe methods are based on Interval Analysis techniques

contractility

correctness

$$\text{NF}_{y=x^2}: Y' \leftarrow Y \cap X^2$$

$$Y' \subseteq Y$$

$$\forall y \in Y \ y \notin Y' \Rightarrow \neg \exists x \in X \ y = x^2$$

$$\text{NF}_{y=x^2}: Y' \leftarrow Y \cap \left(c(Y) - \frac{c(Y) - X^2}{1} \right)$$

$$\text{NF}_{y=x^2}: X' \leftarrow (X \cap -Y^{1/2}) \uplus (X \cap +Y^{1/2})$$

$$X' \subseteq X$$

$$\forall x \in X \ x \notin X' \Rightarrow \neg \exists y \in Y \ y = x^2$$

$$\text{NF}_{y=x^2}: X' \leftarrow X \cap \left(c(X) - \frac{Y - c(X)^2}{-2X} \right)$$

Solving a Continuous Constraint Satisfaction Problem

Constraint Propagation

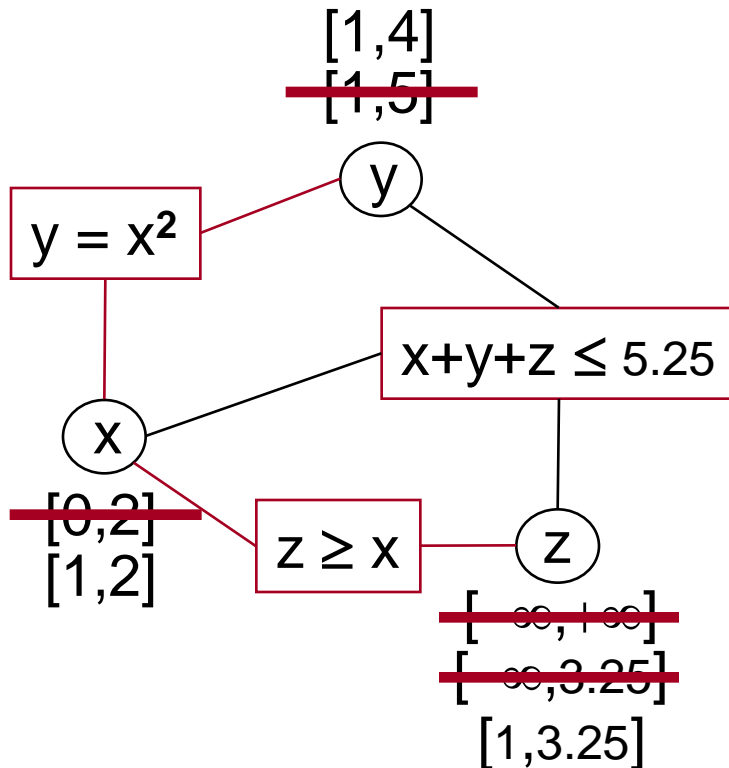

$$NF_{y=x^2}: Y' \leftarrow Y \cap X^2$$

$$\rightarrow \checkmark NF_{y=x^2}: X' \leftarrow (X \cap -Y^{1/2}) \cup (X \cap +Y^{1/2})$$

$$NF_{x+y+z \leq 5.25}: X' \leftarrow X \cap ([-\infty, 5.25] - Y - Z)$$

$$NF_{x+y+z \leq 5.25}: Y' \leftarrow Y \cap ([-\infty, 5.25] - X - Z)$$

$$\rightarrow \checkmark NF_{x+y+z \leq 5.25}: Z' \leftarrow Z \cap ([-\infty, 5.25] - X - Y)$$

$$\rightarrow \checkmark NF_{z \geq x}: X' \leftarrow X \cap (Z - [0, +\infty])$$

$$\rightarrow \checkmark NF_{z \geq x}: Z' \leftarrow Z \cap (X + [0, +\infty])$$

Solving a Continuous Constraint Satisfaction Problem

Constraint Propagation

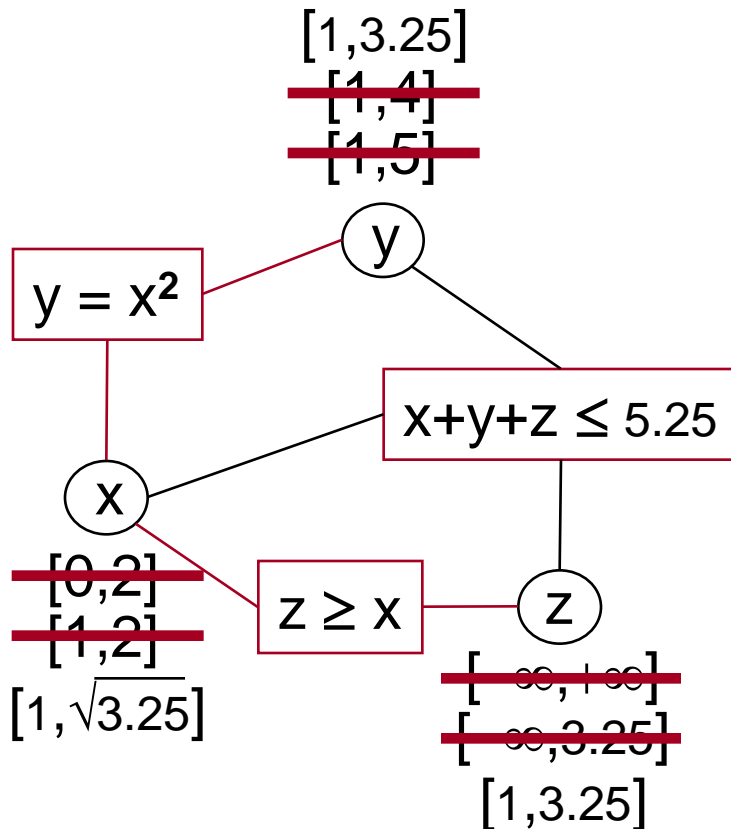

- ✓ $NF_{y=x^2}: Y' \leftarrow Y \cap X^2$
- ✓ $NF_{y=x^2}: X' \leftarrow (X \cap -Y^{1/2}) \uplus (X \cap +Y^{1/2})$
- ✓ $NF_{x+y+z \leq 5.25}: X' \leftarrow X \cap ([-\infty, 5.25] - Y - Z)$
- ✓ $NF_{x+y+z \leq 5.25}: Y' \leftarrow Y \cap ([-\infty, 5.25] - X - Z)$
- ✓ $NF_{x+y+z \leq 5.25}: Z' \leftarrow Z \cap ([-\infty, 5.25] - X - Y)$
- ✓ $NF_{z \geq x}: X' \leftarrow X \cap (Z - [0, +\infty])$
- ✓ $NF_{z \geq x}: Z' \leftarrow Z \cap (X + [0, +\infty])$

Solving a Continuous Constraint Satisfaction Problem

Constraint Propagation + Branching
Consistency Criterion

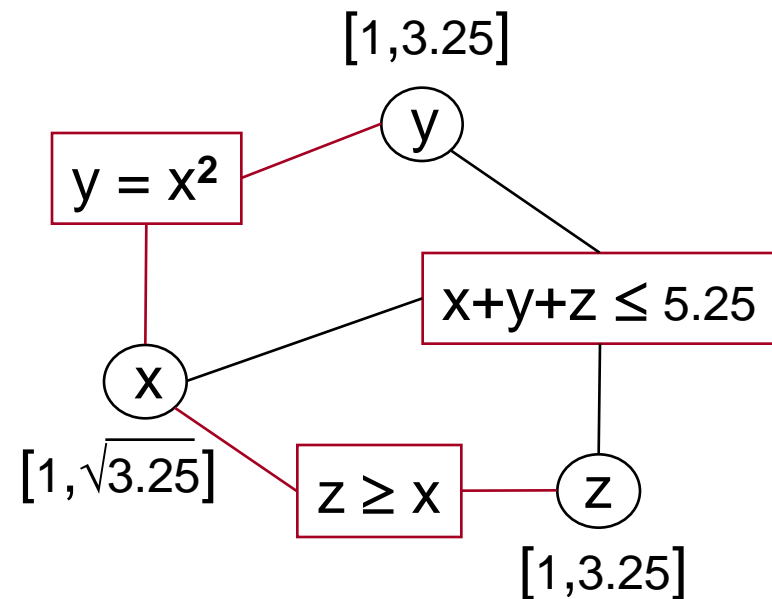

x	y	z	
1	1	1	✓
1	1	3.25	✓
$\sqrt{3.25}$			
1.5	2.25	0.75	✓
			$z \geq x$

$y = x^2 \Rightarrow y = 3.25$
 $x + y + z \leq 5.25 \Rightarrow z \leq 2 - \sqrt{3.25} < \sqrt{3.25}$

Solving a Continuous Constraint Satisfaction Problem

{ Constraint Propagation + Branching
 Consistency Criterion

Local Consistency
(2B-Consistency)

← Constraint Propagation



Higher Order Consistencies
(kB-Consistency)



Constraint Propagation
+
Branching

3B-Consistency: if 1 bound is fixed then the problem is Local Consistent

x	y	z		x	y	z
$[1, \sqrt{3.25}]$	$[1, 3.25]$	$[1, 3.25]$	not 3B-Consistent	$[\sqrt{3.25}]$	$[1, 3.25]$	$[1, 3.25]$
$[1, 1.5]$	$[1, 2.25]$	$[1, 3.25]$	3B-Consistent			not Local Consistent

Example:

Variables: x, y

Domains: $[-2, 2] \times [-2, 10]$

Constraints:

$$y = x^2$$

$$y \geq 2x + 4$$

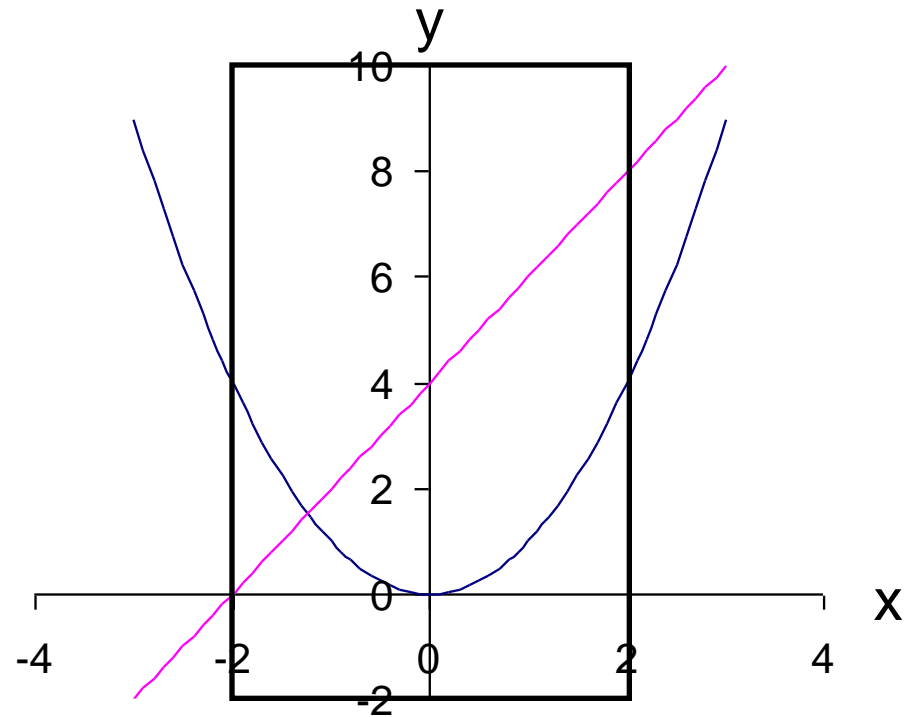

Constraint propagation

define set of narrowing functions:

$$y = x^2$$



$$NF_{y=x^2}: Y' \leftarrow Y \cap X^2$$

$$x = \pm y^{1/2}$$

$$NF_{y=x^2}: X' \leftarrow (X \cap -Y^{1/2}) \cup (X \cap +Y^{1/2})$$

$$y = 2x + [4, +\infty]$$



$$NF_{y \geq 2x+4}: Y' \leftarrow Y \cap (2X + [4, +\infty])$$

$$x = \frac{1}{2}y - [2, +\infty]$$

$$NF_{y \geq 2x+4}: X' \leftarrow X \cap (\frac{1}{2}Y - [2, +\infty])$$

Example:

Variables: x, y

Domains: $[-2,2] \times [-2,10]$

Constraints:

$$y = x^2$$

$$y \geq 2x + 4$$

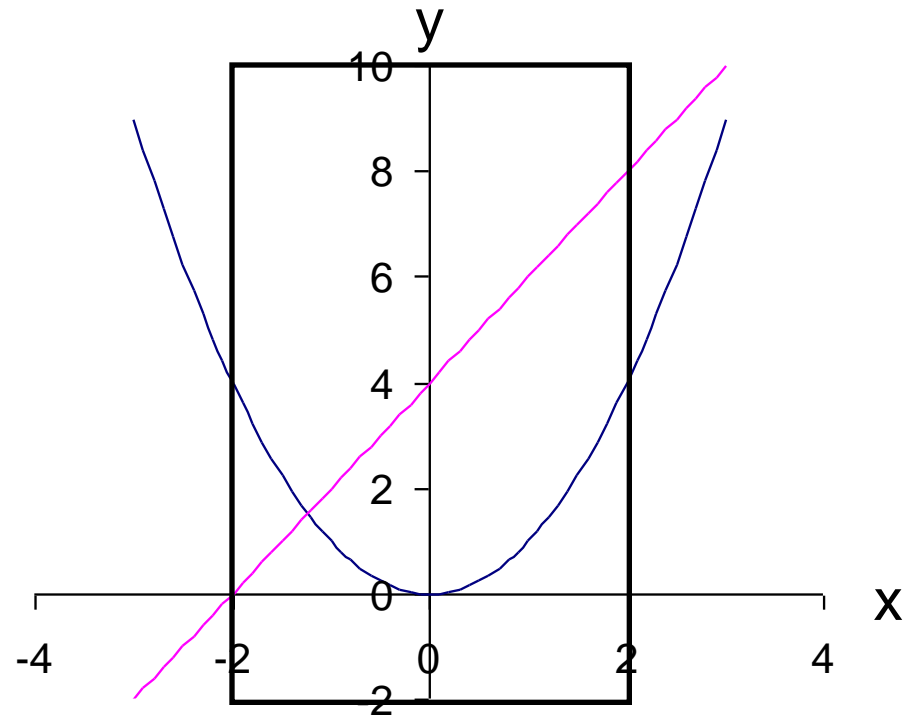

Constraint propagation

apply the narrowing functions to prune box: $[-2,2] \times [-2,10]$

$$[-2,2] \times ([-2,10] \cap [-2,2]^2)$$

$$[-2,2] \times ([-2,10] \cap [0,4])$$

$$[-2,2] \times [0,4]$$



$$NF_{y=x^2}: Y' \leftarrow Y \cap X^2$$

$$NF_{y=x^2}: X' \leftarrow (X \cap -Y^{1/2}) \uplus (X \cap +Y^{1/2})$$

$$NF_{y \geq 2x+4}: Y' \leftarrow Y \cap (2X + [4, +\infty])$$

$$NF_{y \geq 2x+4}: X' \leftarrow X \cap (1/2 Y - [2, +\infty])$$

Example:

Variables: x, y

Domains: $[-2, 2] \times [-2, 10]$

Constraints:

$$y = x^2$$

$$y \geq 2x + 4$$

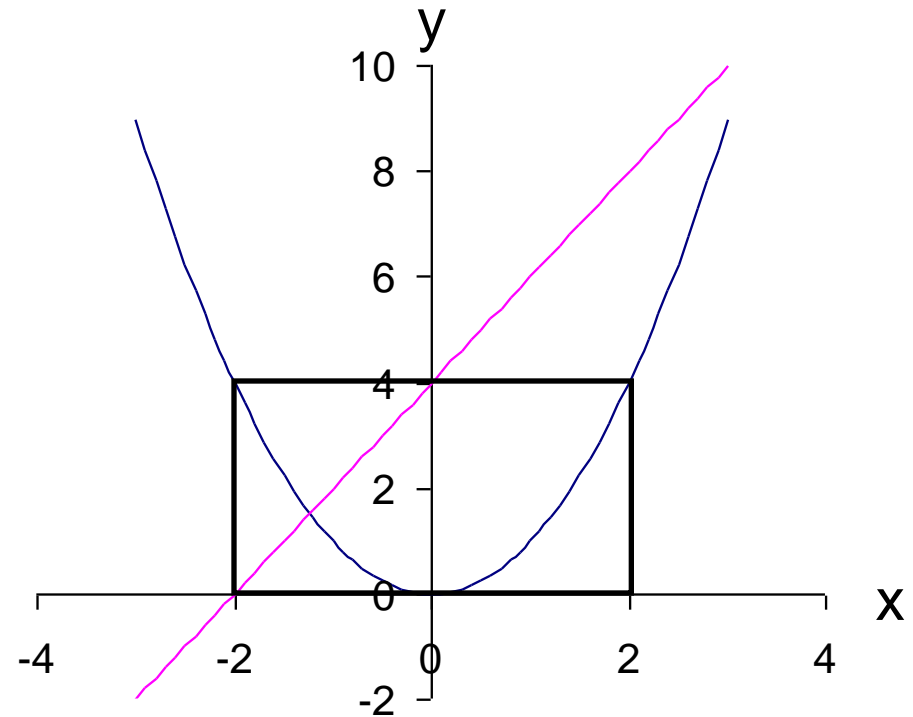

Constraint propagation

apply the narrowing functions to prune box: $[-2, 2] \times [0, 4]$

$$([-2, 2] \cap [-0, 4]^{1/2}) \uplus ([-2, 2] \cap [0, 4]^{1/2}) \times [0, 4]$$

$$([-2, 2] \cap [-2, 0]) \uplus ([-2, 2] \cap [0, 2]) \times [0, 4]$$

$$[-2, 2] \times [0, 4]$$

$$NF_{y=x^2}: Y' \leftarrow Y \cap X^2$$

$$NF_{y=x^2}: X' \leftarrow (X \cap -Y^{1/2}) \cup (X \cap +Y^{1/2})$$

$$NF_{y \geq 2x+4}: Y' \leftarrow Y \cap (2X + [4, +\infty])$$

$$NF_{y \geq 2x+4}: X' \leftarrow X \cap (1/2 Y - [2, +\infty])$$

Example:

Variables: x, y

Domains: $[-2,2] \times [-2,10]$

Constraints:

$$y = x^2$$

$$y \geq 2x + 4$$

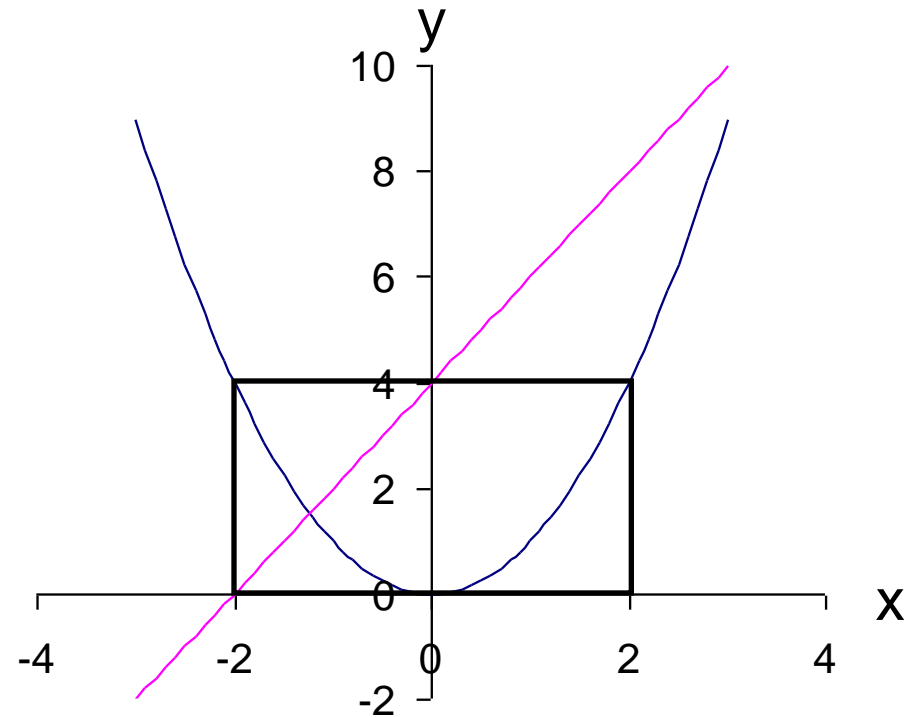

Constraint propagation

apply the narrowing functions to prune box: $[-2,2] \times [0,4]$

$$[-2,2] \times ([0,4] \cap (2[-2,2] + [4,+\infty)))$$

$$[-2,2] \times ([0,4] \cap ([-4,4] + [4,+\infty)))$$

$$[-2,2] \times ([0,4] \cap [0,+\infty])$$

$$[-2,2] \times [0,4]$$

$$NF_{y=x^2}: Y' \leftarrow Y \cap X^2$$

$$NF_{y=x^2}: X' \leftarrow (X \cap -Y^{1/2}) \cup (X \cap +Y^{1/2})$$

$$\leftarrow NF_{y \geq 2x+4}: Y' \leftarrow Y \cap (2X + [4,+\infty])$$

$$NF_{y \geq 2x+4}: X' \leftarrow X \cap (1/2 Y - [2,+\infty])$$

Example:

Variables: x, y

Domains: $[-2,2] \times [-2,10]$

Constraints:

$$y = x^2$$

$$y \geq 2x + 4$$

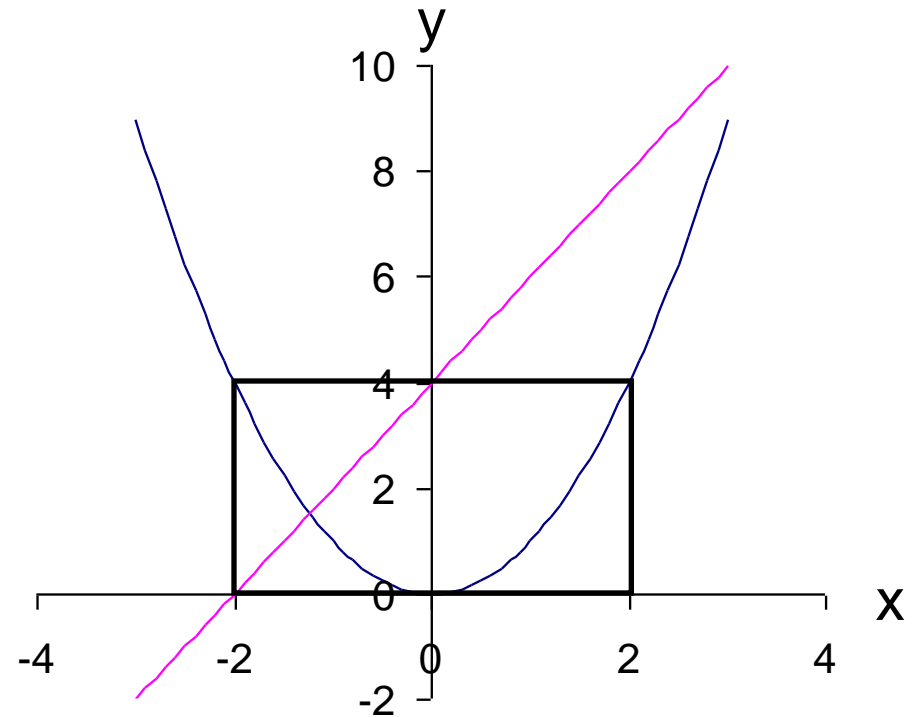

Constraint propagation

apply the narrowing functions to prune box: $[-2,2] \times [0,4]$

$$([-2,2] \cap (\frac{1}{2}[0,4] - [2,+\infty])) \times [0,4]$$

$$([-2,2] \cap ([0,2] - [2,+\infty])) \times [0,4]$$

$$([-2,2] \cap [-\infty, 0]) \times [0,4]$$

$$[-2,0] \times [0,4]$$

$$NF_{y=x^2}: Y' \leftarrow Y \cap X^2$$

$$NF_{y=x^2}: X' \leftarrow (X \cap -Y^{1/2}) \cup (X \cap +Y^{1/2})$$

$$NF_{y \geq 2x+4}: Y' \leftarrow Y \cap (2X + [4, +\infty])$$

$$\leftarrow NF_{y \geq 2x+4}: X' \leftarrow X \cap (\frac{1}{2}Y - [2, +\infty])$$

Example:

Variables: x, y

Domains: $[-2,2] \times [-2,10]$

Constraints:

$$y = x^2$$

$$y \geq 2x + 4$$

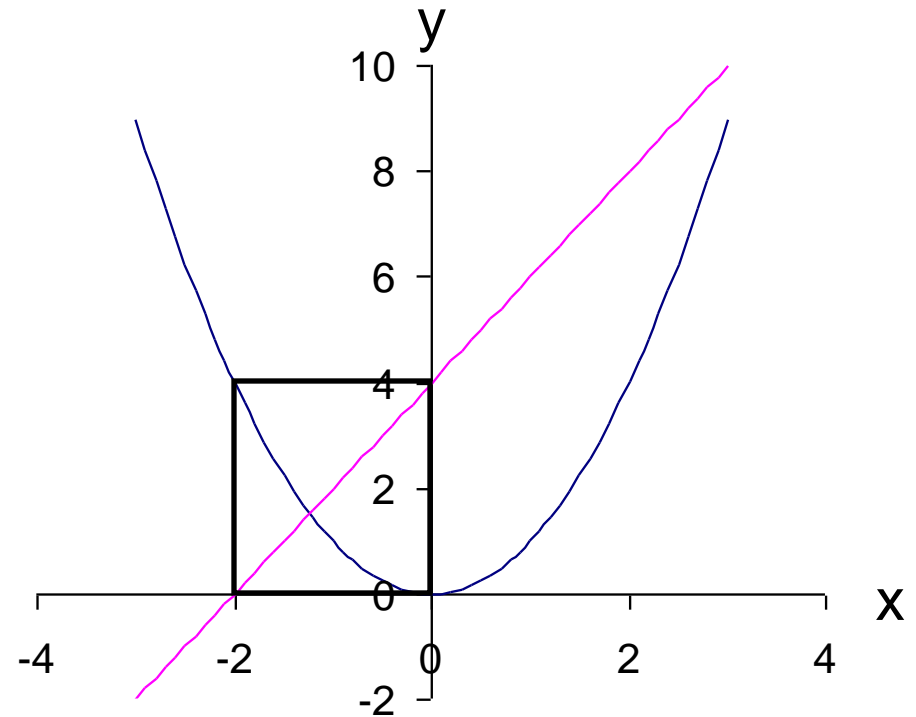

Constraint propagation

obtained the box: $[-2,0] \times [0,4]$ (fixed point)

$$NF_{y=x^2}: Y' \leftarrow Y \cap X^2$$

$$NF_{y=x^2}: X' \leftarrow (X \cap -Y^{1/2}) \cup (X \cap +Y^{1/2})$$

$$NF_{y \geq 2x+4}: Y' \leftarrow Y \cap (2X + [4, +\infty])$$

$$NF_{y \geq 2x+4}: X' \leftarrow X \cap (1/2 Y - [2, +\infty])$$

Example:

Variables: x, y

Domains: $[-2, 2] \times [-2, 10]$

Constraints:

$$y = x^2$$

$$y \geq 2x + 4$$

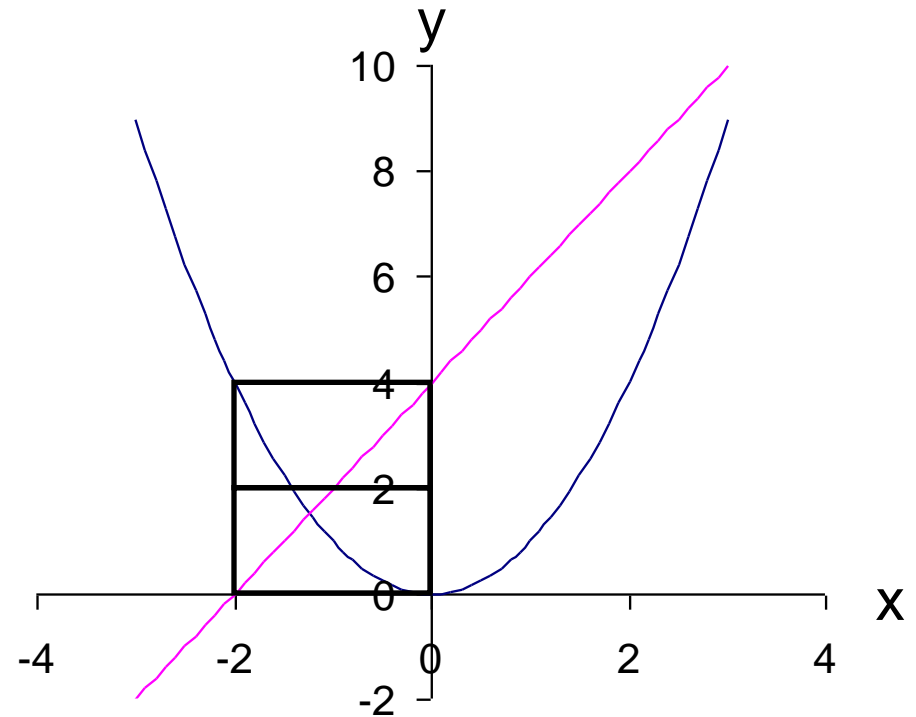

Split box

$$[-2, 0] \times [0, 2]$$

$$[-2, 0] \times [2, 4]$$

Example:

Variables: x, y

Domains: $[-2,2] \times [-2,10]$

Constraints:

$$y = x^2$$

$$y \geq 2x + 4$$

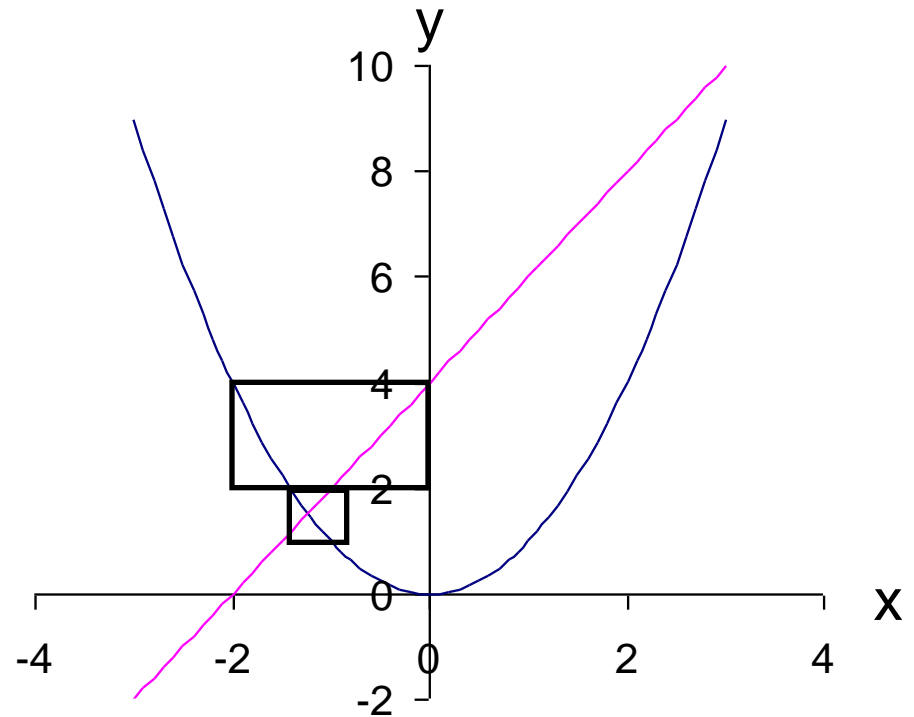

Split box

$[-2,0] \times [0,2]$ $\xrightarrow{\text{prune}}$ $[-1.415, -1.082] \times [1.171, 2.000]$ (fixed point)

$[-2,0] \times [2,4]$

Example:

Variables: x, y

Domains: $[-2,2] \times [-2,10]$

Constraints:

$$y = x^2$$

$$y \geq 2x + 4$$

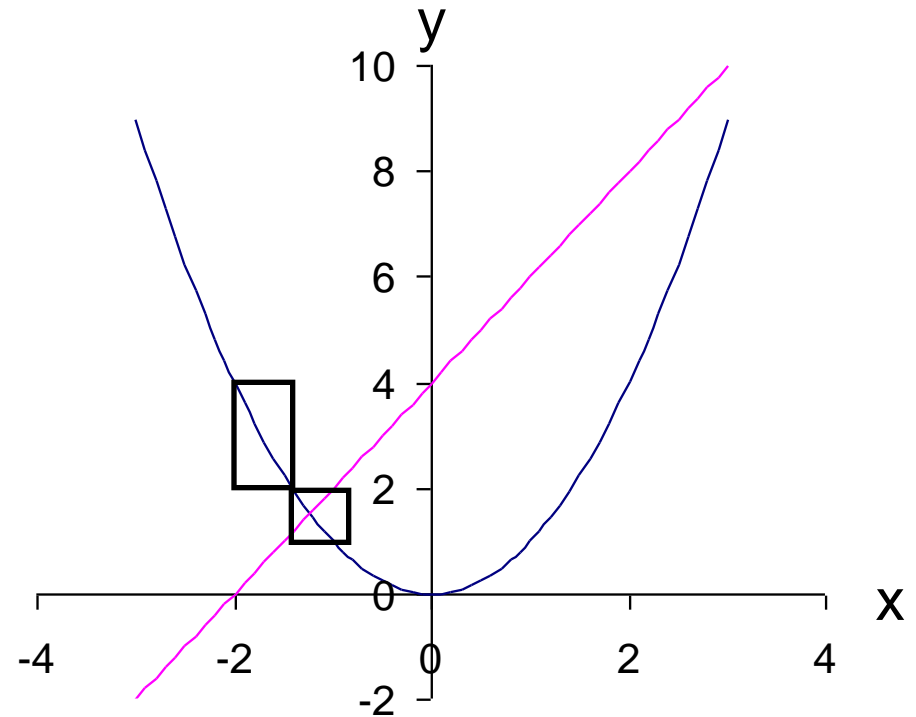

Split box

$[-2,0] \times [0,2]$ $\xrightarrow{\text{prune}}$ $[-1.415, -1.082] \times [1.171, 2.000]$ (fixed point)

$[-2,0] \times [2,4]$ $\xrightarrow{\text{prune}}$ $[-2.000, -1.414] \times [2.000, 4.000]$ (fixed point)

Example:

Variables: x, y

Domains: $[-2, 2] \times [-2, 10]$

Constraints:

$$y = x^2$$

$$y \geq 2x + 4$$

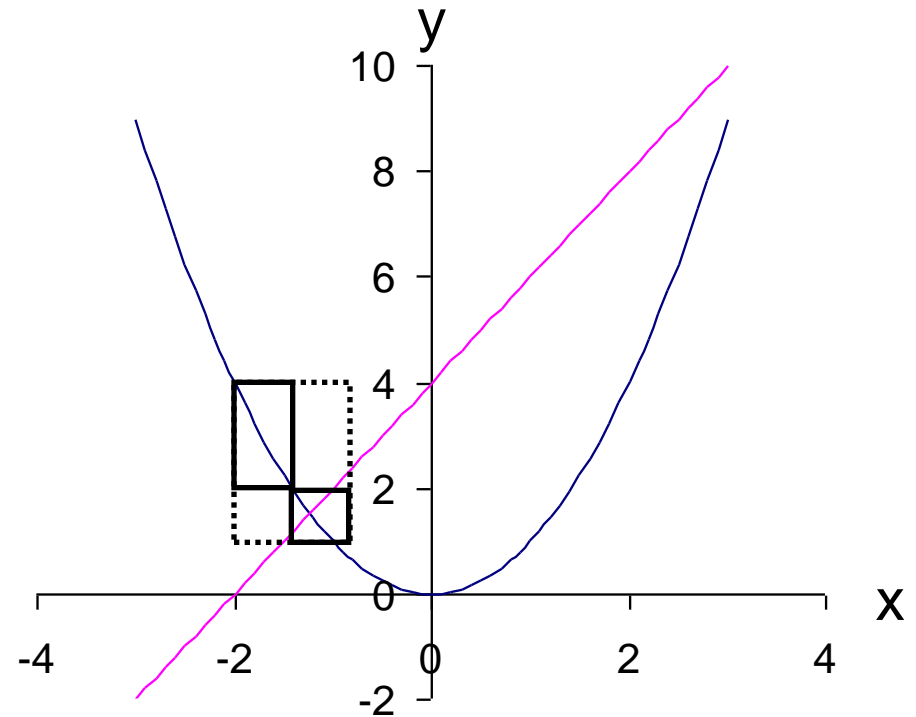

When to stop? \longrightarrow Consistency requirement

if we stop now:

$$[-1.415, -1.082] \times [1.171, 2] \cup [-2, -1.414] \times [2, 4] = [-2, -1.082] \times [1.171, 4]$$

Example:

Variables: x, y

Domains: $[-2, 2] \times [-2, 10]$

Constraints:

$$y = x^2$$

$$y \geq 2x + 4$$

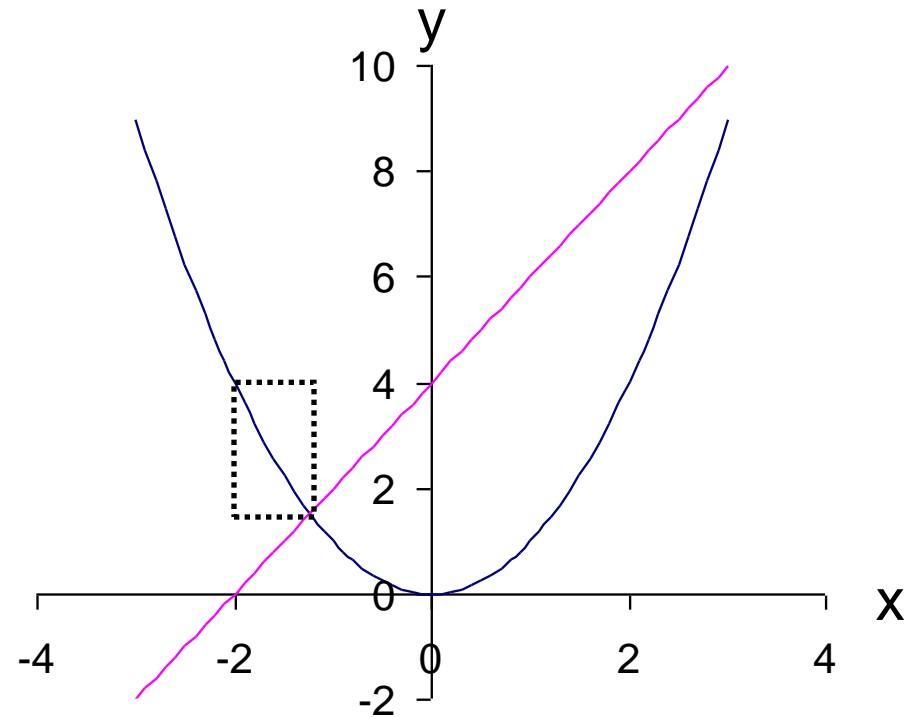

When to stop? \longrightarrow Consistency requirement

smallest box containing all canonical solutions

Continuous Constraint Programming

Continuous Constraint Satisfaction Problem:

$$x \in [-\pi, \pi] \quad y \in [-\pi, \pi]$$

$$x^2 y + xy^2 \leq 0.5$$

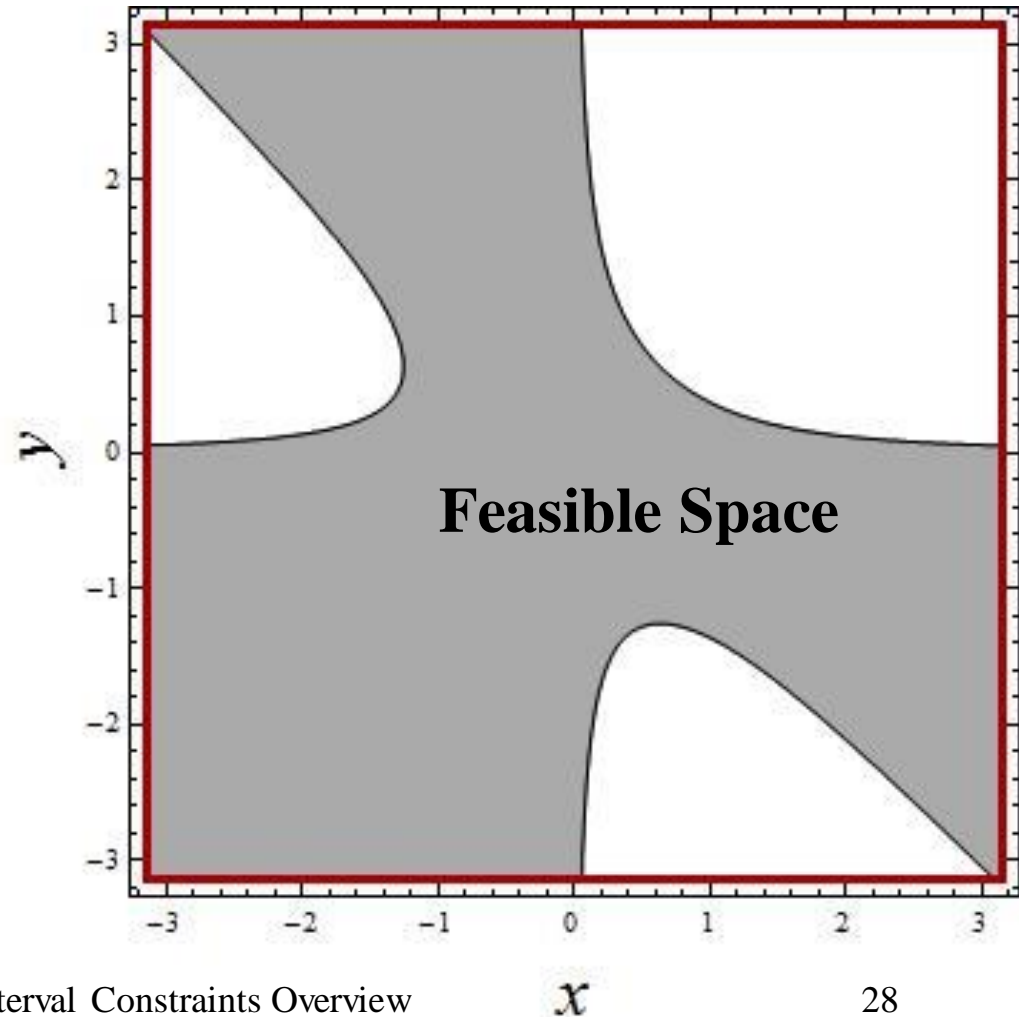

Continuous Constraint Programming

Continuous Constraint Satisfaction Problem:

$$x \in [-\pi, \pi] \quad y \in [-\pi, \pi]$$

$$x^2 y + xy^2 \leq 0.5$$

Branch & Prune Algorithms:

- **one** solution
- feasible space **box cover**

Prune Techniques:

- Interval Analysis
- Constraint Propagation

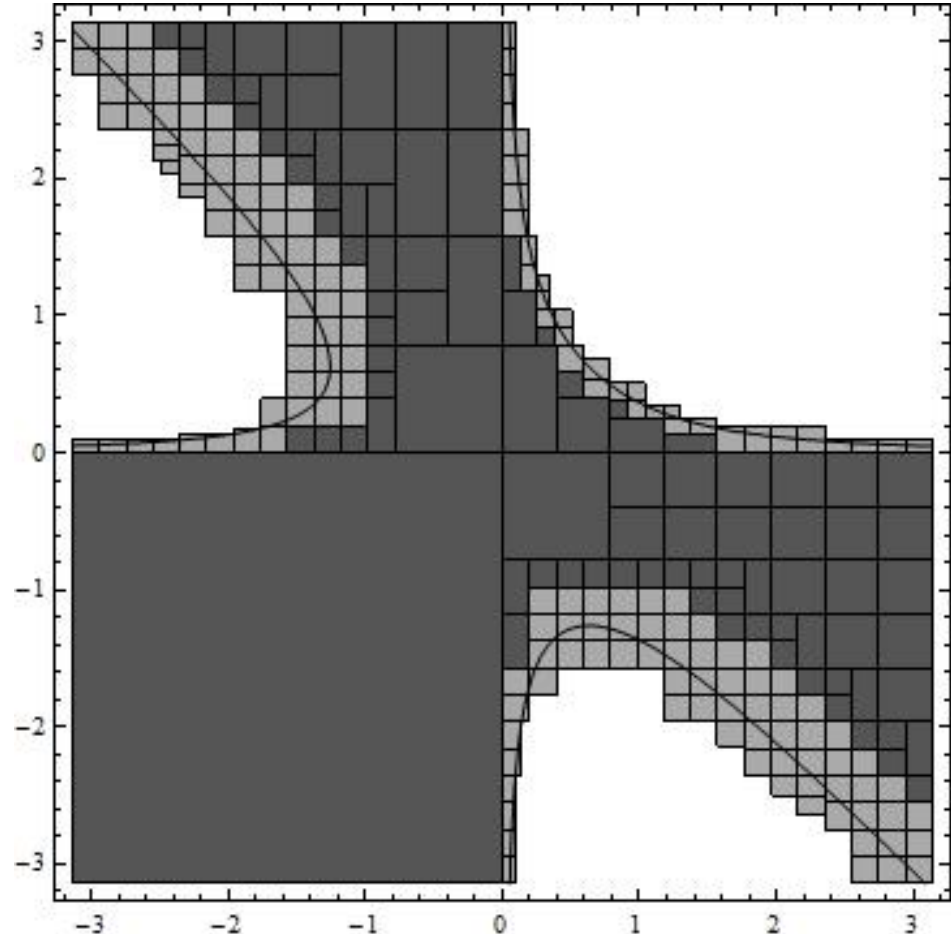

Interval Analysis

$$x^2 y + xy^2 \leq 0.5$$

Inner Box ?

$$x \in [-\pi, 0]$$

$$y \in [-\pi, 0]$$

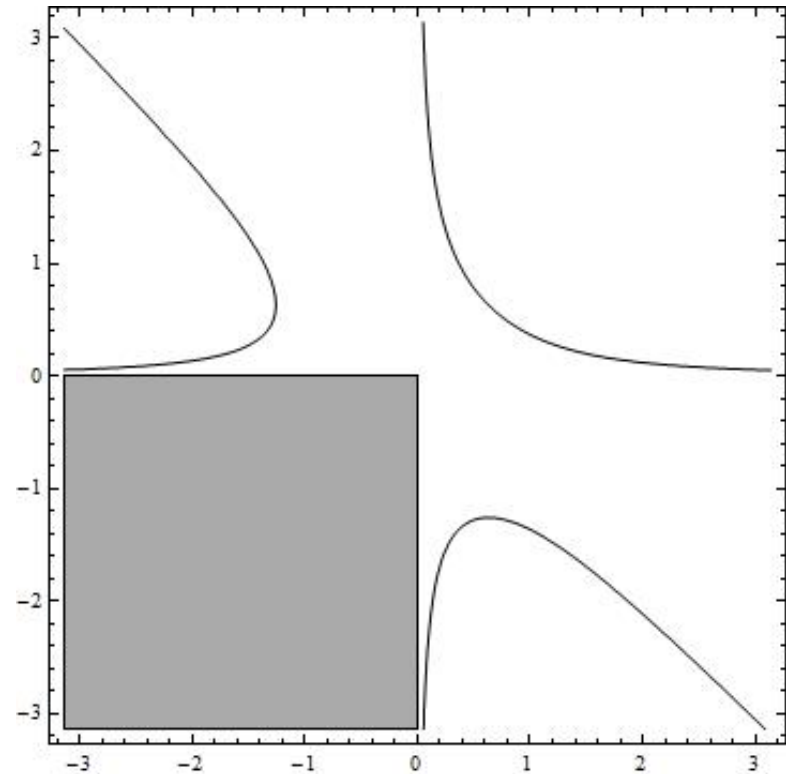

Interval Analysis

$$x^2 y + xy^2 \leq 0.5$$

Interval
Arithmetic

Inner Box



$$x \in [-\pi, 0]$$

$$y \in [-\pi, 0]$$

$$[-\pi, 0]^2 [-\pi, 0] + [-\pi, 0] [-\pi, 0]^2 =$$

$$[-2\pi^3, 0] \leq 0.5$$

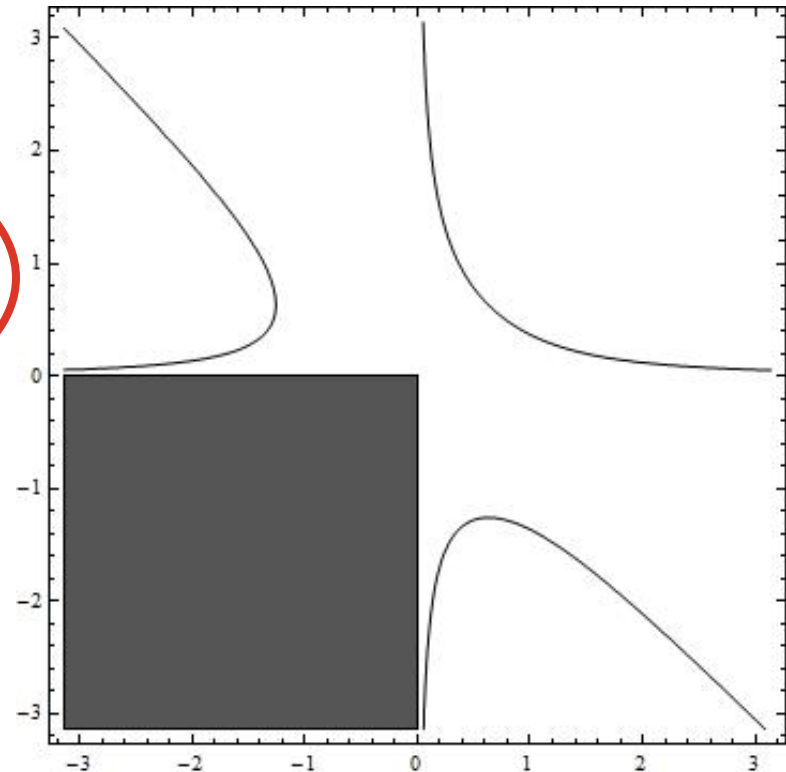

Interval Analysis

$$x^2 y + xy^2 \leq 0.5$$

**Non-solution
Box ?**

$$x \in [\pi/2, \pi]$$
$$y \in [\pi/2, \pi]$$

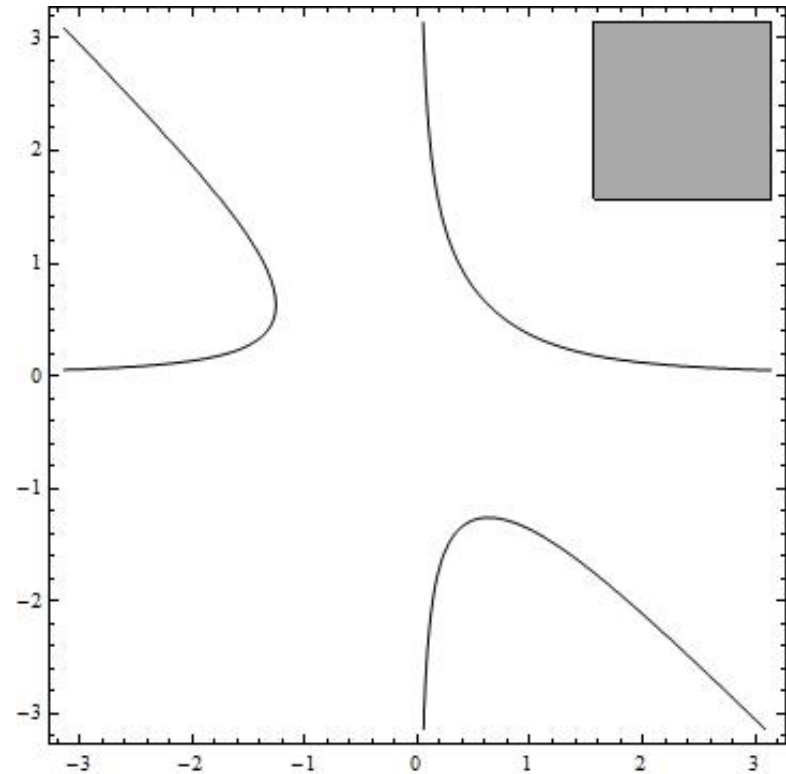

Interval Analysis

$$x^2 y + xy^2 \leq 0.5$$

Interval
Arithmetic

**Non-solution
Box** ✓

$$x \in [\pi/2, \pi]$$
$$y \in [\pi/2, \pi]$$

$$[\pi/2, \pi]^2 [\pi/2, \pi] + [\pi/2, \pi] [\pi/2, \pi]^2 =$$
$$[\pi^3/4, \pi^3] \leq 0.5$$
 ✖

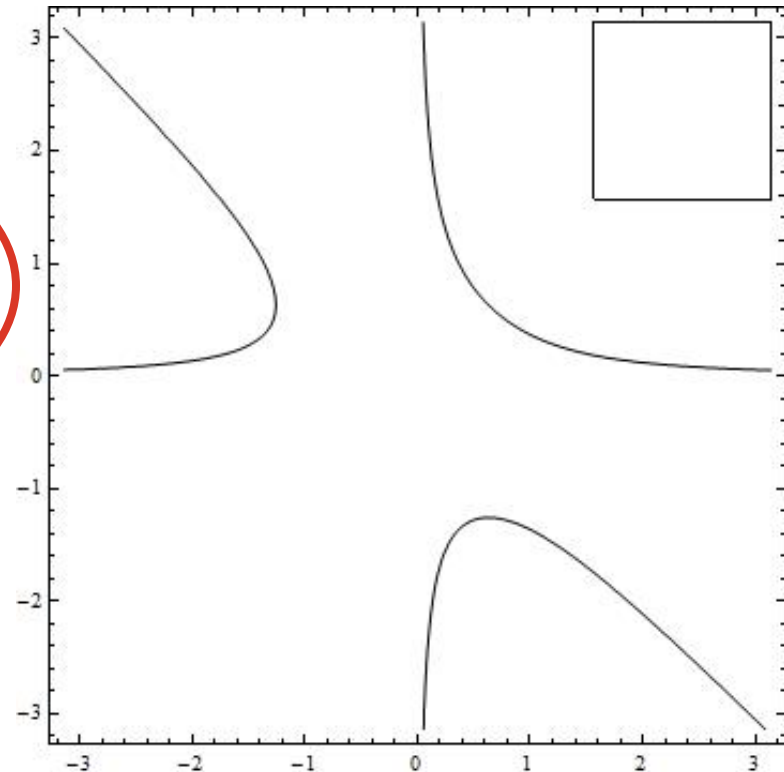

Interval Analysis

$$x^2 y + xy^2 - 0.5 \leq 0$$

Prune Boundary Box

$$[3\pi/4, \pi] \times [0, \pi/4]$$

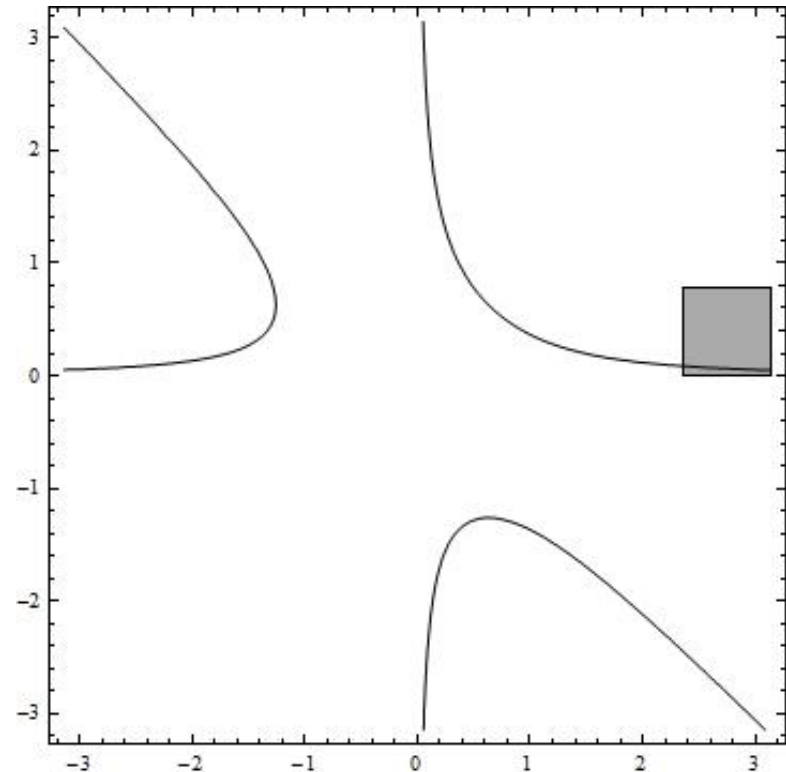

Interval Analysis

$$x^2 y + xy^2 - 0.5 \leq 0$$

Prune Boundary Box

$$[3\pi/4, \pi] \times [0, \pi/4]$$



Newton step

$$[3\pi/4, \pi] \times [0, 0.2547]$$

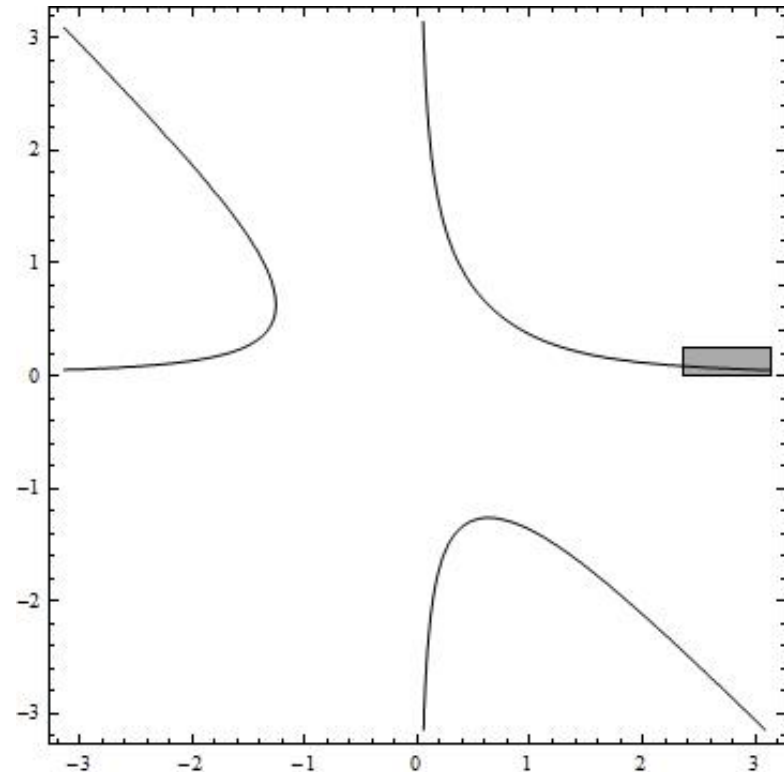

Interval Analysis

$$x^2 y + xy^2 - 0.5 \leq 0$$

Prune Boundary Box

$$[3\pi/4, \pi] \times [0, \pi/4]$$



Newton step

$$[3\pi/4, \pi] \times [0, 0.2547]$$



Newton steps

$$[3\pi/4, \pi] \times [0, 0.0874]$$

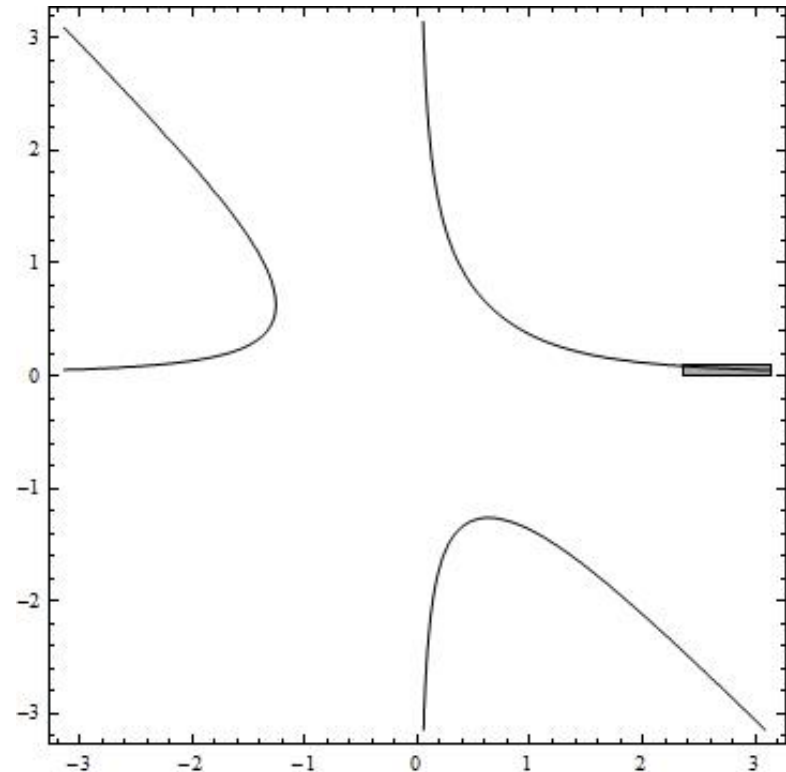

Continuous Constraint Programming

Continuous Constraint Reasoning:

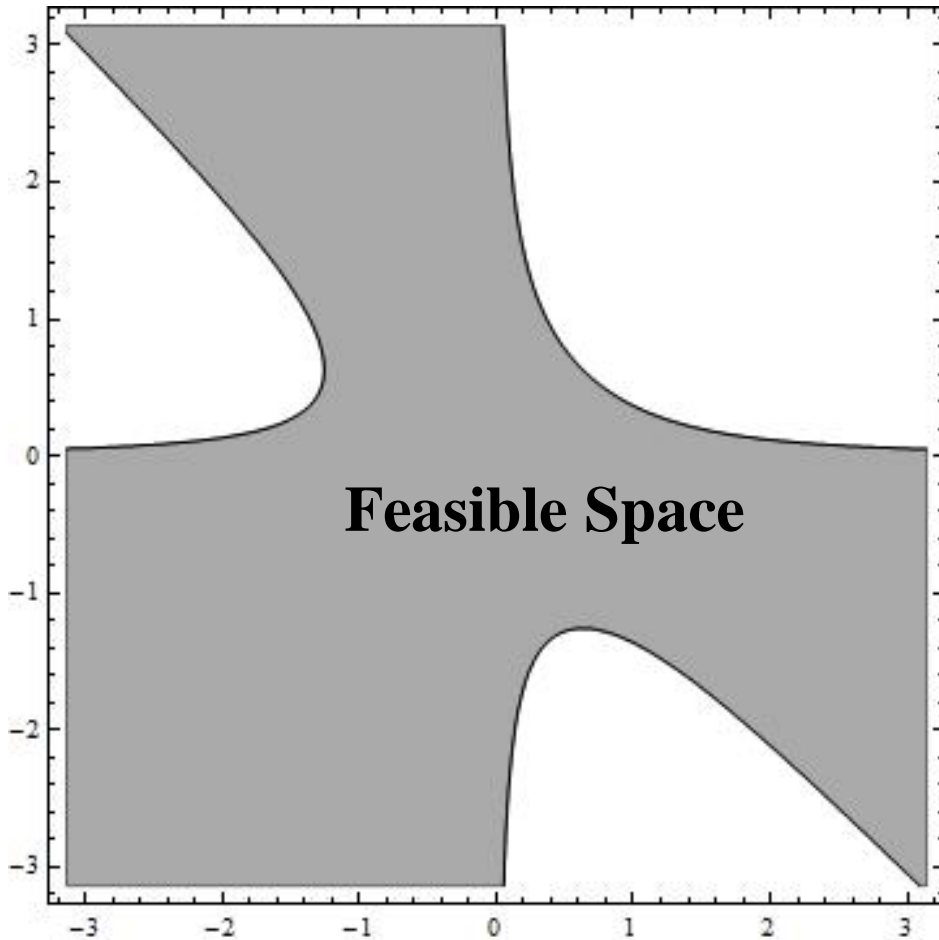

all solutions

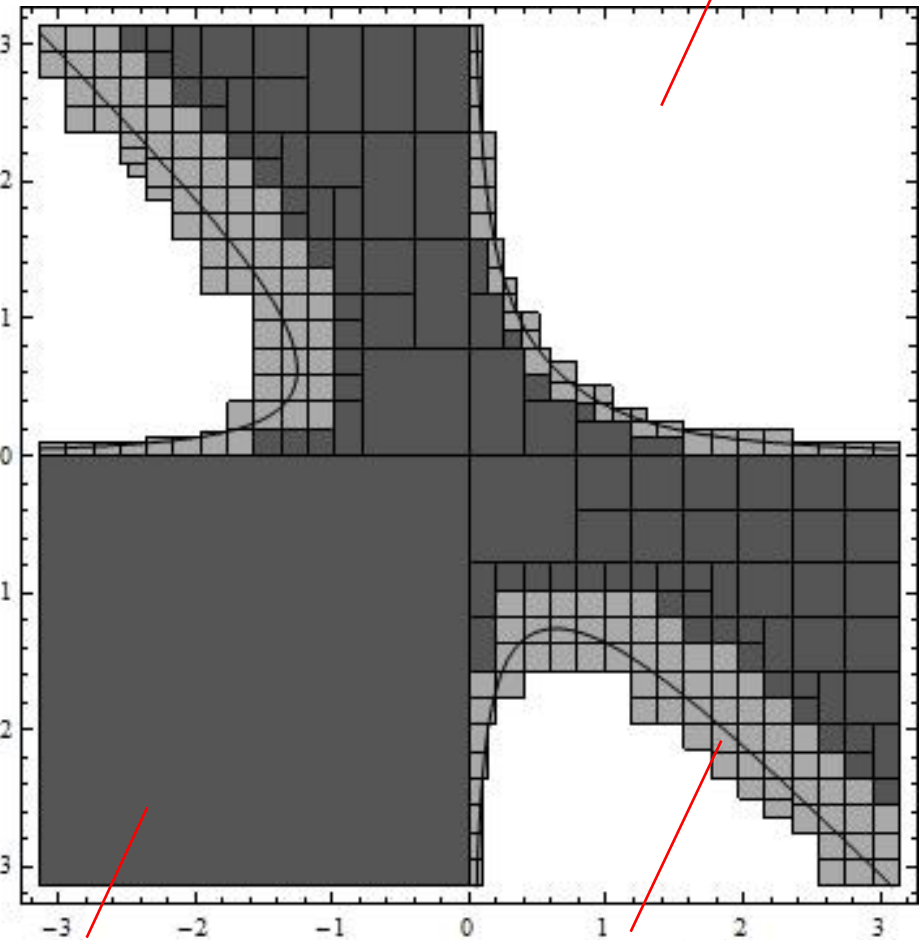

no solutions

may contain solutions

A practical example:

Population
(millions)

Census USA

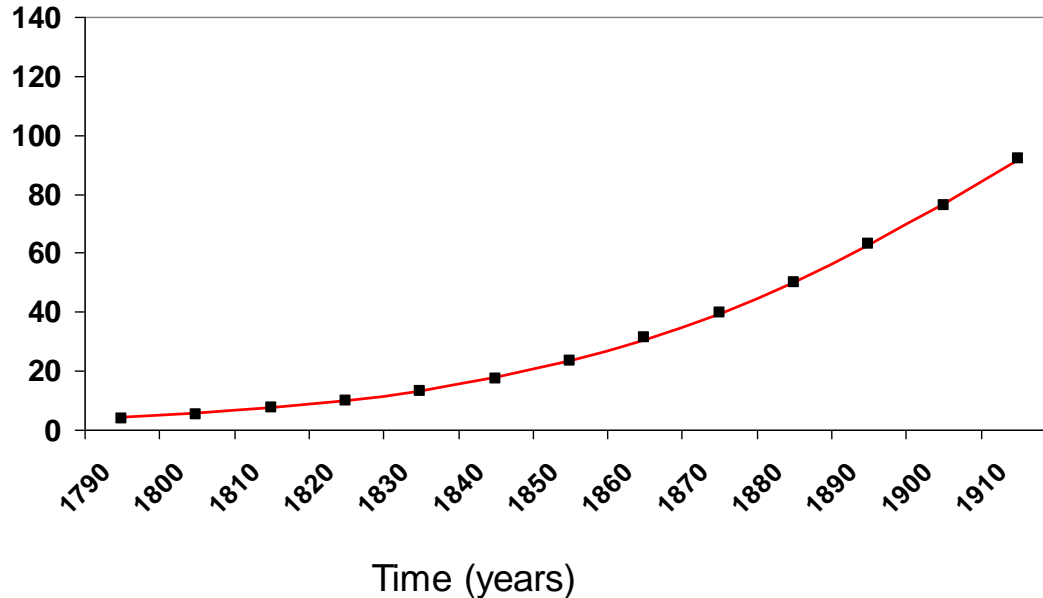

Logistic Model

$$x(t) = \frac{kx_0 e^{r(t-t_0)}}{x_0(e^{r(t-t_0)} - 1) + k}$$

result:
$$\begin{cases} x_0 = a \\ k = b \\ r = c \end{cases}$$

Optimization Problem:
$$\min \sum_i (x_i - v_i)^2$$
 with
$$x_i = \frac{kx_0 e^{r(t_i-t_0)}}{x_0(e^{r(t_i-t_0)} - 1) + k}$$

A practical example:

Population
(millions)

Census USA

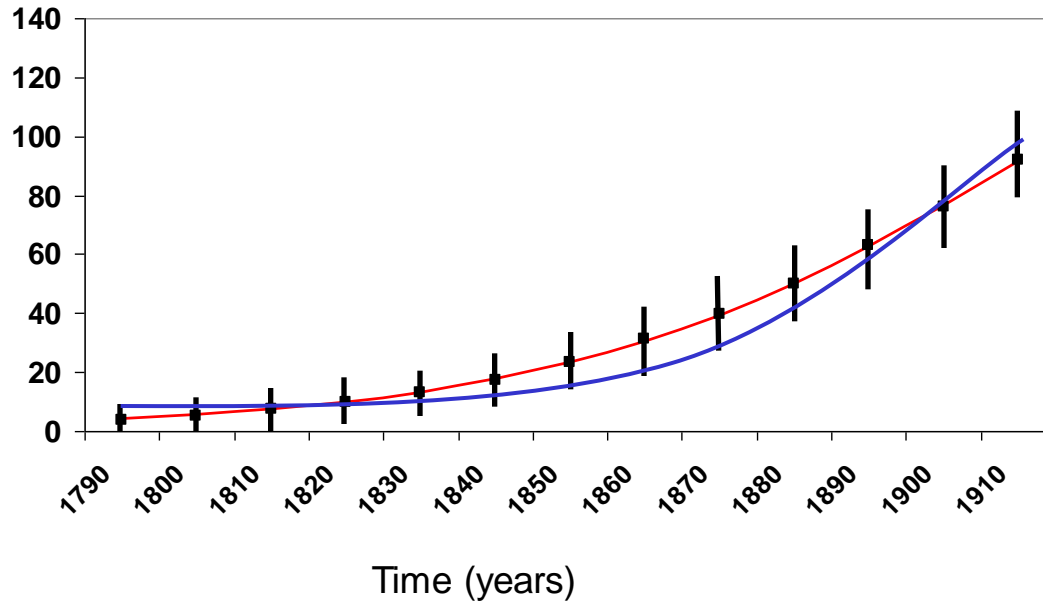

Logistic Model

$$x(t) = \frac{kx_0 e^{r(t-t_0)}}{x_0(e^{r(t-t_0)} - 1) + k}$$

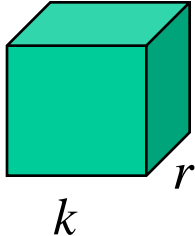
result: x_0 

$$\text{CCSP: } \left\{ \langle x_0, k, r \rangle \mid \forall (t_i, v_i) x_i = \frac{kx_0 e^{r(t_i-t_0)}}{x_0(e^{r(t_i-t_0)} - 1) + k} \wedge |x_i - v_i| \leq \varepsilon_i \right\}$$

Course Structure: Constraints on Continuous Domains

Lecture 1: Interval Constraints Overview

Lecture 2: Intervals, Interval Arithmetic and Interval Functions

Lecture 3: Interval Newton Method

Lecture 4: Associating Narrowing Functions to Constraints

Lecture 5: Constraint Propagation and Consistency Enforcement

Lecture 6: Problem Solving

Bibliography

- Jorge Cruz. [*Constraint Reasoning for Differential Models*](#)
Vol: 126 Frontiers in Artificial Intelligence and Applications, IOS Press 2005
- Ramon E. Moore. *Interval Analysis*
Prentice-Hall 1966
- Eldon Hansen, G. William Walster. [*Global Optimization Using Interval Analysis*](#)
Marcel Dekker 2003
- Jaulin, L., Kieffer, M., Didrit, O., Walter, E. [*Applied Interval Analysis*](#)
Springer 2001

Important Links

- [*Interval Computations*](#)
A primary entry point to items concerning interval computations.
- [*COCONUT - COntinuous COntstraints Updating the Technology*](#)
Project to integrate techniques from mathematical programming, constraint programming, and interval analysis.

Papers

- O. Lhomme. Consistency Techniques for Numeric CSPs. In Proceedings of 13th IJCAI, 232–238, 1993.
- F. Benhamou, D. A. McAllester, and P. Van Hentenryck. CLP(Intervals) Revisited. In SLP, 124–138, 1994.
- F. Benhamou and W. Older. Applying interval arithmetic to real, integer and boolean constraints. Journal of Logic Programming, pages 1–24, 1997.
- P. Van Hentenryck, D. McAllester, and D. Kapur. Solving polynomial systems using a branch and prune approach. SIAM J. Num. Anal., 34(2):797–827, 1997.
- F. Benhamou, F. Goualard, L. Granvilliers, and J. F. Puget. Revising Hull and Box Consistency. In Proceedings of ICLP, 230–244, Las Cruces, New Mexico, USA. The MIT Press, 1999.
- L. Granvilliers, J. Cruz, and P. Barahona, Parameter Estimation Using Interval Computations, SIAM Journal on Scientific Computing (SISC) Special Issue on Uncertainty Quantification, 26(2):591-612, 2004.
- J. Cruz and P. Barahona, Constraint Reasoning in Deep Biomedical Models, Journal of Artificial Intelligence in Medicine, 34:77-88, Elsevier, 2005.

Papers

- G. Trombettoni and G. Chabert. Constructive Interval Disjunction. In Proceedings of the 13th International Conference on Principles and Practice of Constraint Programming - CP 2007, 635–650, 2007.
- I. Araya, B. Neveu, G. Trombettoni. Exploiting Common Subexpressions in Numerical CSPs, In Proceedings of the 14th International Conference on Principles and Practice of Constraint Programming - CP 2008, Springer, 342–357, 2008.
- P. Barahona and L. Krippahl, Constraint Programming in Structural Bioinformatics, Constraints, 13(1-2):3-20, Springer, 2008.
- M. Rueher, A. Goldsztejn, Y. Lebbah, and C. Michel. Capabilities of Constraint Programming in Rigorous Global Optimization. International Symposium on Nonlinear Theory and Its Applications - Nolta 2008, 2008.
- E. Carvalho, J. Cruz, and P. Barahona. Probabilistic continuous constraint satisfaction problems. In Proceedings of the 20th IEEE International Conference on Tools with Artificial Intelligence - Vol. 2, 155-162, IEEE 2008.
- X. H. Vu, H. Schichl, D. Sam-Haroud. Interval propagation and search on directed acyclic graphs for numerical constraint solving, Journal of Global Optimization, 45:499–531, 2009.

Papers

- G. Chabert and L. Jaulin. Hull Consistency under Monotonicity, In Proceedings of the 15th International Conference on Principles and Practice of Constraint Programming - CP 2009, Springer, 188–195, 2009.
- I. Araya, G. Trombettoni, B. Neveu. Filtering numerical CSPs using well-constrained subsystems, In Proceedings of the 15th International Conference on Principles and Practice of Constraint Programming - CP 2009, Springer, 158–172, 2009.
- A. Goldsztejn, C. Michel, M. Rueher. Efficient handling of universally quantified inequalities, *Constraints*, 14(1): 117–135, 2009.
- A. Goldsztejn, F. Goualard. Box Consistency through Adaptive Shaving, Proceedings of the 25th Annual ACM Symposium on Applied Computing (CSP track), ACM, 2010.
- I. Araya, G. Trombettoni, B. Neveu. Making adaptive an interval constraint propagation algorithm exploiting monotonicity. In Proceedings of the 16th International Conference on Principles and Practice of Constraint Programming - CP 2010, Springer, 61-68, 2010.

Papers

- B. Neveu, G. Trombettoni, G. Chabert, Improving inter-block backtracking with interval Newton, *Constraints*, 15:93–116, 2010.
- J. M. Normand, A. Goldsztejn, M. Christie, F. Benhamou. A branch and bound algorithm for numerical Max-CSP, *Constraints*, 15(2): 213-237, 2010.
- E. Carvalho, J. Cruz, and P. Barahona. Probabilistic Constraints for Reliability Problems, *Proceedings of the 2010 ACM Symposium on Applied Computing*, ACM, 2055-2060, 2010.
- A. Goldsztejn, L. Granvilliers, A New Framework for Sharp and Efficient Resolution of NCSP with Manifolds of Solutions, *Constraints*, 15(2): 190-212, 2010.
- E. Carvalho, J. Cruz, and P. Barahona. Reasoning with Uncertainty in Continuous Domains, *Integrated Uncertainty Management and Applications*, *Advances in Intelligent and Soft Computing*, 68: 357-369, Springer, 2010.